

Schnitt S2(5:1)

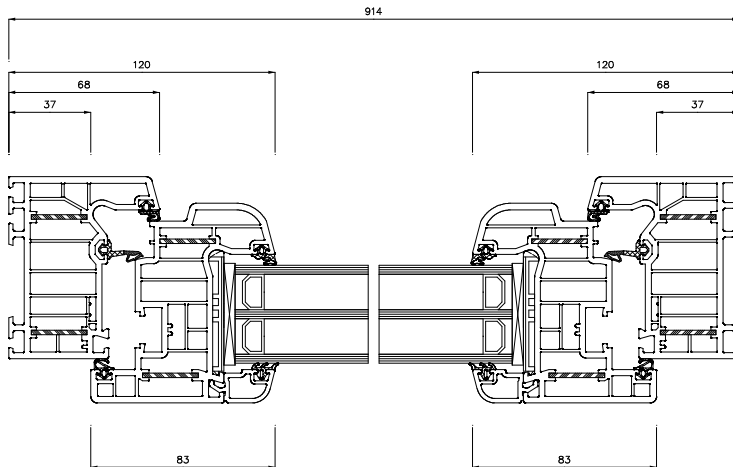

Schnitt S1(5:1)