

Passive House, Little Compton, RI
Design: ZeroEnergy Design, P.C.
Product: Schüco SI82 Tilt-Sliding door, p.19

■ ■ EUROPEAN
■ ■ ARCHITECTURAL
■ ■ SUPPLY

FINE WINDOWS FOR ALL SEASONS

fine windows
today & tomorrow

SCHÜCO

North American Distributor
of Fine European Windows

MAKROWIN®

windows & doors

Today, and for tomorrow, our attention must focus on the conservation of energy and our planet's natural resources. With this need, environmentally friendly products that minimize our carbon footprint are in demand more than ever.

European Architectural Supply meets this demand by bringing the state-of-the-art in custom, energy efficient fenestration solutions in wood, uPVC and aluminum from Europe to North America.

EAS offers the finest custom, tilt-and-turn windows and doors manufactured with German-engineered cutting edge technology, blending performance, function and style adaptable to both contemporary and traditional architecture. Each product is uniquely handcrafted to a designer's specifications with the highest dedication to quality, and then shipped directly to the customer's building site.

Our European window manufacturers, Makrowin and Schüco, are our chosen brands proven in the market for custom windows and doors unparalleled in energy efficiency.

Bringing Fine European Fenestration to North America for Ten Years

for the 21st century



EUROPEAN
ARCHITECTURAL
SUPPLY

FINE WINDOWS FOR ALL SEASONS

uPVC products 12

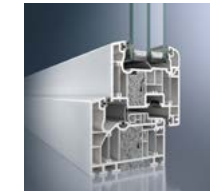

Wood products 20



Aluminum products 30

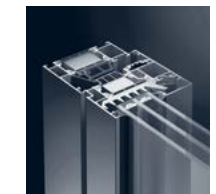

Curtain Wall products 37

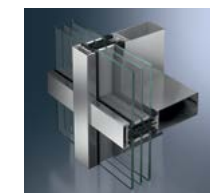

Door products 19, 29, 35

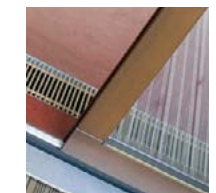

SCHÜCO North American Distributor of Fine European Windows
MAKROWIN

Passive House
Little Compton, RI Residence
Design: ZeroEnergy Design, P.C.

Product:
Schüco SI82 TP uPVC Windows
Glass: R-10 Triple-Pane, SHGC 0.60

dwell in the future

net zero energy impact

Passive House Leader

EAS is proud to be the leading provider of Passive House windows and doors in North America. We provide a complete offering of European-made products for the Passive House building community, including wood, aluminum and uPVC windows and doors.

Our experience with high-performance building envelopes makes EAS a great partner for architects interested in bringing their project to Net-Zero or Passive House standards.

glass up to R-14

passive house certified



Schüco SI82 Thermoplus

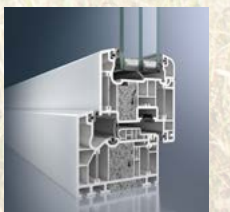

Schüco uPVC windows are certified by the Passive House Institute (PHI) in Darmstadt, achieving $U_i = 0.134$ Btu/(hr.ft².F°), making them one of the best value-to-performance options for Passive House projects. See p.13 for more detail.

enjoy luxury and efficiency

design with a conscience

Lincoln, MA Residence

Design: Morehouse
MacDonald & Associates

Product:

Makrowin MW78 Wood Windows
Glass: R-5 Double-Pane

Beauty Meets Efficiency

You no longer have to sacrifice aesthetics for energy performance. Our products enable architects to create designs that inspire, communicate quality of life, and at the same time achieve a high level of sustainability.

Handcrafted from the finest materials and manufactured at the highest energy efficiency standards, these windows are a perfect blend of the finest European craftsmanship and state-of-the-art technology.

Our European custom tilt-turn windows blend performance, function and style and are adaptable to both traditional and contemporary architecture. Each product is uniquely handcrafted to our customer's specifications with the highest attention to quality.

sustainable luxury

unparalleled energy performance

Makrowin MW78 Double-Pane



This project required the traditional look of SDL (Simulated Divided Lites) muntins on double-pane glass. MW78 provided R-5 energy performance with $U_{cog}=0.19 \text{ Btu}/(\text{hr}\cdot\text{ft}^2\cdot\text{F}^\circ)$. The windows were manufactured from sustainably harvested Philippine Mahogany, creating a furniture-like look. See p. 25 for more detail.



Brookline, MA Residence
Design: ZeroEnergy Design, P.C.

Product:
Schüco FW50+.SI Curtain Wall
Glass: R-10 Triple-Pane, SHGC 0.60

Sophistication and Durability

Our curtain wall systems are ideal for designs that aim to bring the outdoors in, and set new standards when it comes to care, maintenance and durability. Using the most sophisticated design features, we can offer optimum solutions for our clients' needs while meeting the strictest energy efficiency standards. These products are ideal for architects and clients who want to combine the clean lines of a curtain wall system with uncompromising performance.

super-insulated curtain wall

room with your view

passive house performance

glass up to R-14

unobstructed sightlines



Schüco FW50+ .SI Curtain Wall

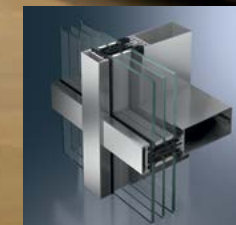

With a face width of 50mm (2"), FW50 uses the narrowest mullions in the industry, making it ideal for designs that require sleek sightlines. Capable of holding glass up to 64mm in thickness (2 1/2"), the FW50 can achieve truly unparalleled performance up to R-14. See p. 38 for more detail.

green your commercial building

large-scale energy efficiency

commercial doors & windows

Schüco ADS90.SI Door System



Schüco ADS90 is the most advanced aluminum door system in the world. Capable of holding triple-pane glass up to R-14, this door can achieve an overall $U_d=0.17$ Btu/(hr-ft²-F°). The ADS door system is available with ADA thresholds, panic bar hardware, coordinated door closers, electronic multi-point locks and handicap openers, making it the most versatile commercial door on the market. See p. 36 for more detail.

passive house performance

Passive House Construction
Hollis Montessori School
Hollis, NH
Design: Windy Hill Associates

Products:
Schüco ADS75 Aluminum Doors
Schüco SI82 uPVC Windows
Glass: R-10 Triple-pane, SHGC=0.50



Commercial Scale Passive House

EAS offers state-of-the-art products for the commercial markets that satisfy the new trends in energy efficiency in large-scale projects. We have considerable experience with the emergent large-scale Passive House and Net-Zero industry, tackling the unique needs of commercial construction in terms of documentation, delivery, installation supervision and maintenance. We are experienced in the complete building process and we work closely with architects and builders to ensure that each phase of work receives the level of communication and support required to make the entire project an unqualified success.

uPVC

products

Schüco SI82 Thermoplus | 13

PHI Certified Triple-Pane Window



Schüco SI82 | 15

PH Performance Triple-Pane Window



Schüco CT70 | 17

Top Performance Double-Pane Window



Schüco uPVC Doors | 19

Entry, Patio, Lift-Slide & Tilt-Slide Doors



Little Compton, RI Residence

Design: ZeroEnergy Design

Aedi Construction

Product:

Schüco SI82 ThermoPlus

Glass: R-10 Triple-Pane

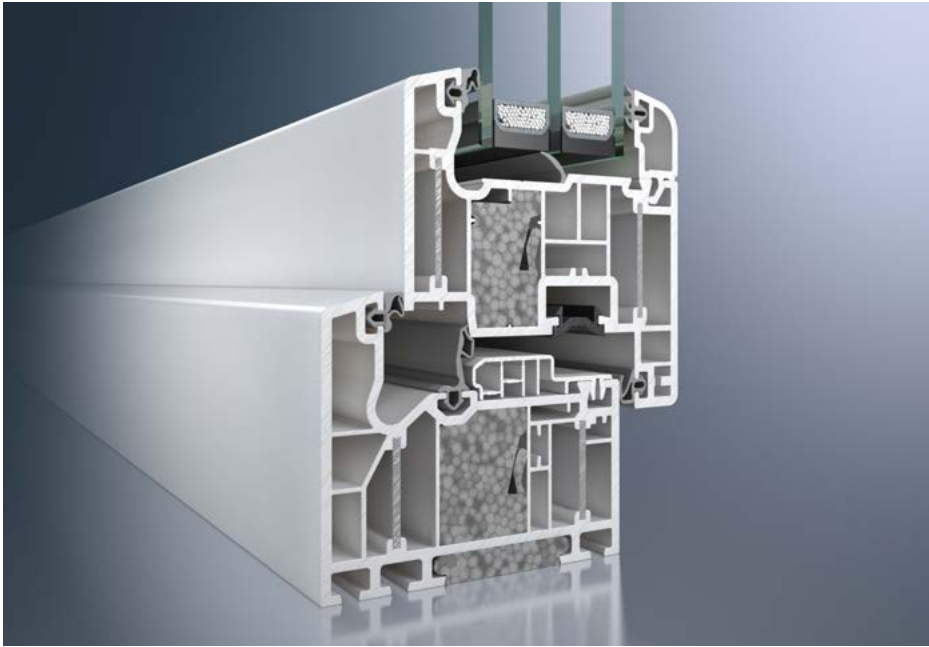

Schüco ThermoPlus

With its outstanding thermal insulation properties, the Schüco ThermoPlus energy-saving window provides both exclusivity and a sense of well-being. Schüco SI82 ThermoPlus energy-saving windows allow you to save up to 33% of your previous energy requirements when replacing your old windows with new ones. For a traditional single family home, that is on average over 450 gallons of heating oil per year. At the same time, you help the environment by reducing CO₂ emissions by approximately five tons.

When selecting uPVC window systems, you look for quality, design and innovation. The Schüco uPVC window systems combine these features into a diverse product range, offering the greatest possible design freedom with maximum planning reliability. Choose the ideal window system to suit the requirements of your building project. Basic requirements are best fulfilled with a 60 mm outer-frame depth, more sophisticated requirements with a basic depth of 70 mm. The window systems with an 82 mm basic depth are the premium range and fulfill high requirements in low energy construction.

The Schüco SI82 ThermoPlus uPVC system with three drainage levels and patented aluminum reinforcement rolling technology is based on 7-chamber uPVC technology. This high-insulation system can be used to build passive and net-zero energy buildings with narrow face widths for houses, economically and to high standards.

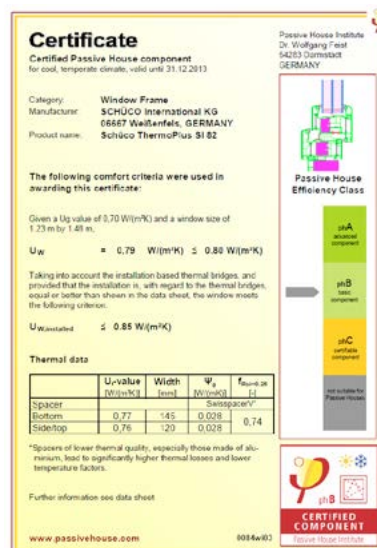

Passive House Certified

The Schüco SI82 ThermoPlus, our highest performing uPVC window frame, is certified by the Passivhaus Institute in Darmstadt achieving $U_f=0.13$ Btu/(hr. ft².°F).

Glass up to R-14, SHGC 0.62

Partnering with Saint Gobain Glass, we use the most innovative glass substrates in the world. Our triple-pane glass reaches up to R-14 and SHGC=0.62, giving PH designers greater flexibility when modeling projects in PHPP.

Premium Finish Options

Our uPVC windows are available in a wide selection of woodgrain and single color decorative foils. Our RAL-certified, high quality decorative foils are weather-resistant, fade-resistant and have been successfully used for decades.



Golden Oak Finish

Matching Doors

The SI82 ThermoPlus profile system is compatible with SI82 system for entry doors, patio doors and tilt-sliding doors, providing for a unified frame and sash design.

SCHÜCO

North American Distributor
of Fine European Windows

MAKROWIN

Schüco SI82 ThermoPlus Passive House Certified uPVC Profile

Energy Efficiency

- Profile construction with optimized chamber geometry and a basic frame depth of 82 mm for excellent thermal insulation
- Large volume chambers for inserting additional, prefabricated insulation
- U_f value from 0.75 to 0.98 W/(m²K)
- Steel and insulating foam-free frame construction
- Vent overlap of 8 mm minimizes heat loss
- Glass edge cover of 18 mm guarantees minimal heat loss in the glass edge seal area
- Triple glazing with a glass thickness of up to 52 mm possible
- Excellent thermal insulation due to weather-resistant outer-frame rebate gasket

Comfort

- Narrow face widths ensure maximum light penetration
- Excellent sound reduction values
- Flush glazing bead makes the windows easy to clean
- Gasket clearance of 5 mm ensures the windows close smoothly

Design

- Narrow face width of 120 mm highlights the slim-lined look of the window
- Various glazing bead contours as a design feature
- Silver-grey gaskets on white profiles for discrete appearance
- The flush fitting gaskets blend in perfectly with the appearance of the window
- Profiles can be colored with a large selection of wood grains and single color decorative foils
- A comprehensive range of aluminum cover caps is available for integration in aluminum façades

Security

- Corner pivot fixed in the vent with screws through three uPVC walls
- Fittings axis of 13 mm allows the use of burglar-resistant hardware
- Increased basic depth for added security and burglar resistance
- All hardware components are protected from corrosion and against dirt by the outer-frame rebate gasket

Parameters	
Frame depth	82 mm 3.23 in
Frame face width	120 mm 4.72 in
Possible glazing thickness	18 - 52 mm 0.71 - 2.05 in
Thermal insulation U_f	0.75 - 0.98 W/(m ² K) 0.13 - 0.17 Btu/(hr. ft ² . °F)

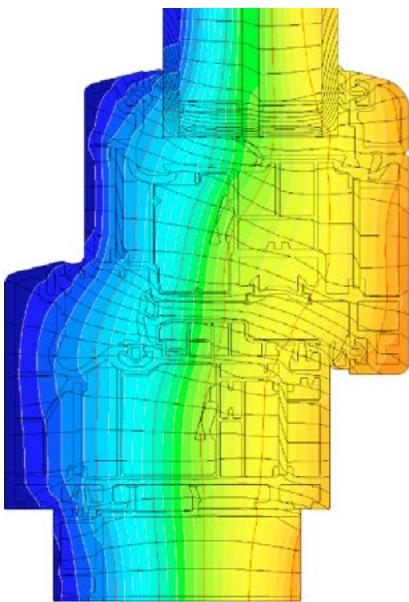

Isothermal flow in Schüco ThermoPlus

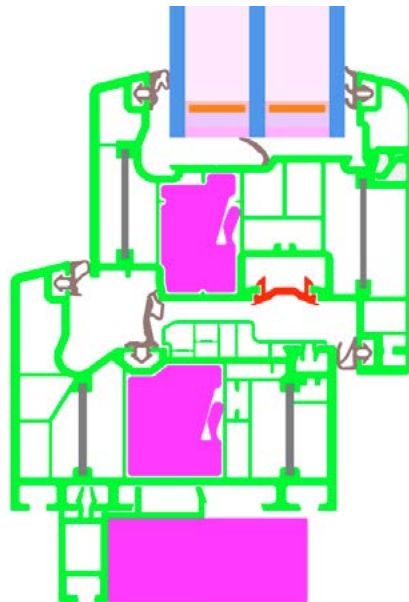

Sill section detail of Schüco ThermoPlus

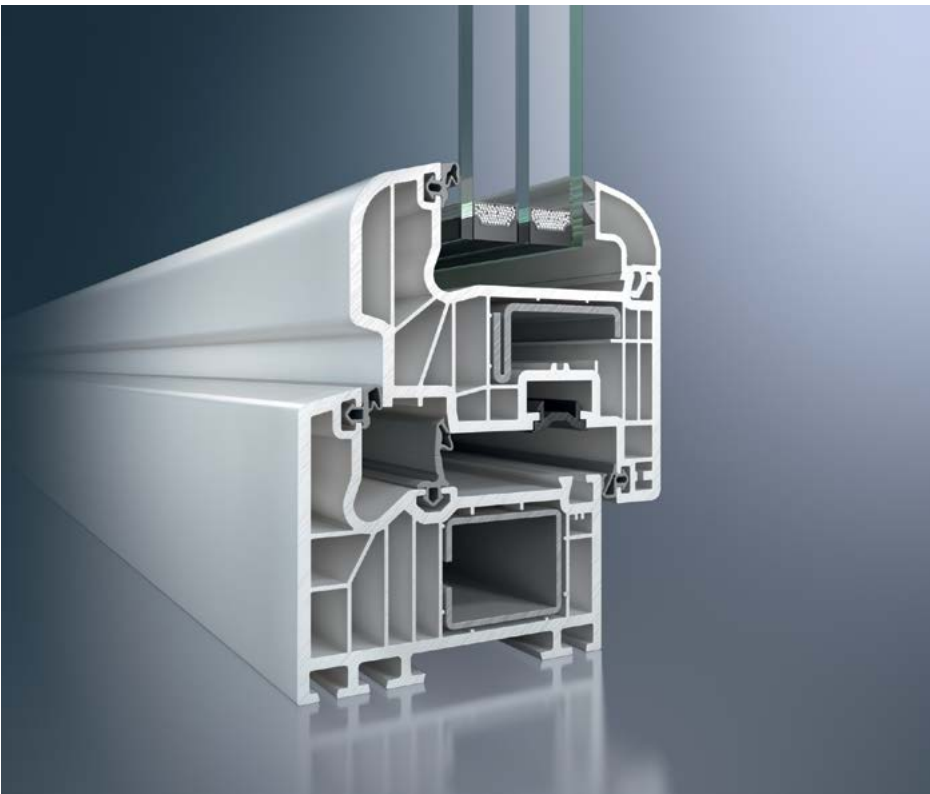

Schüco SI82 Rondo

uPVC systems with a basic depth of 82 mm achieve high thermal insulation values with the narrowest of face widths. These profile systems are the ideal answer to rising energy costs and more stringent environmental protection demands.

When selecting uPVC window systems, you look for quality, design and innovation. The Schüco uPVC window systems combine these features in a diverse product range, offering architects a great degree of design flexibility. Choose the ideal window system to suit the requirements of your building project. The SI82 window system with the 82 mm basic depth is the perfect choice for high efficiency triple-pane applications.

Schüco SI82 window systems have three levels of drainage and conventional steel reinforcing profiles. Thanks to industrial fabrication and fast availability, they can now be used to build low-energy windows for houses economically and to high standards. SI82 window and door systems

are suitable for a wide variety of uses in both new-build and renovation projects. An extensive range of accessories ensures a high level of system security.

Passive House Performance

Combined with R-10 triple-pane glass, SI82 is capable of achieving Passive House performance metrics, making it the most affordable uPVC option for PH projects. The added strength of SI82 frames enables the use of larger window openings up to 8 ft in height.

Glass up to R-14, SHGC 0.62

Partnering with Saint Gobain Glass, we use the most innovative glass substrates in the world. Our triple-pane glass reaches up to R-14 and SHGC=0.62, giving PH designers greater flexibility when modeling projects in PHPP.

Premium Finish Options

Our uPVC windows are available in a wide selection of wood grain and single color decorative foils. Our RAL-certified, high quality decorative foils are weather-resistant, fade-resistant and have been successfully used for decades.



Palette of wood and color finishes

Matching Doors

The SI82 profile system is also available for entry doors, patio doors and tilt-sliding doors providing for a unified frame and sash design.

Schüco SI82

Passive House Performace Triple-Pane Windows

Energy Efficiency

- Profile construction with optimized chamber geometry and a basic frame depth of 82 mm for excellent thermal insulation
- Uf value from 1.0 to 1.1 W/(m²K)
- Vent overlap of 8 mm minimizes heat loss
- Glass edge cover of 18 mm guarantees minimal heat loss in the glass edge seal area
- Triple glazing with a glass thickness of up to 52 mm possible
- Optimum thermal insulation due to weather-resistant outer-frame rebate gasket

Design

- Vent profiles are available in two different contours (Classic, Rondo)
- Narrow face width of 120 mm (standard profile combination) highlights the slim-lined look of the window
- Remarkable contours with concise softform radii and sloping exposed faces
- Various glazing bead contours as a design feature
- White profiles are supplied with modern, silver-grey gaskets; foiled profiles with black gaskets as standard
- The flush fitting gaskets blend perfectly with the window's appearance
- Profiles can be colored with a large selection of wood grains and single color decorative foils
- A comprehensive range of aluminum cover caps is available for integration in aluminum façades

Security

- Corner pivot fixed in the vent with screws through three uPVC walls
- Depending on structural requirements, various reinforcing profiles in the outer and vent frames ensure that the windows are highly robust and durable
- Special screw ports for fixing the corner pivot in the vent
- Fittings axis of 13 mm allows the use of burglar-resistant hardware
- Security locking keeps with a screw fixing

in the steel reinforcement can be used for increased security requirements

- All hardware components are protected from corrosion and against dirt by the outer-frame rebate gasket

Comfort

- Narrow face widths ensure maximum light penetration
- Excellent sound reduction values (depending on the profile combination and glazing, sound insulation values up to $R_{w,p}$ 47 dB are possible)
- Flush glazing bead makes the windows easy to clean
- Gasket clearance of 5 mm ensures the windows close smoothly

Parameters	
Frame depth	82 mm 3.23 in
Frame face width	120 mm 4.72 in
Possible glazing thickness	18 - 52 mm 0.71 - 2.05 in
Thermal insulation U_f	1.0 - 1.1 W/(m².K) 0.18 - 0.19 Btu/(hr. ft².°F)
Sound insulation $R_{w,p}$	47 dB

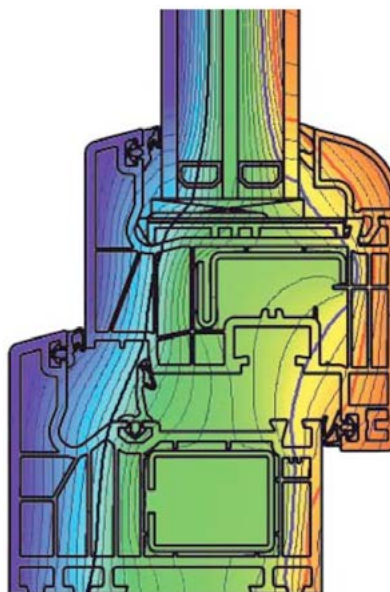

Isothermal flow in Schüco SI82 Classic

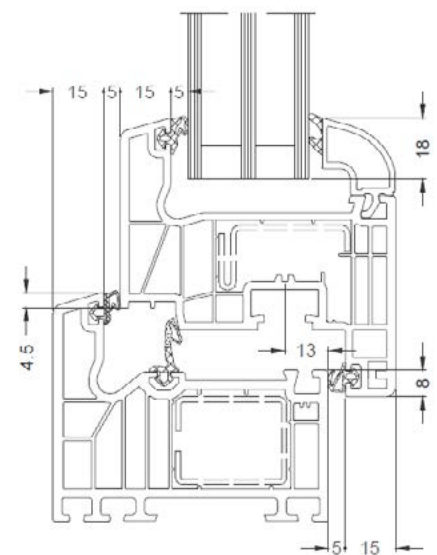

Section detail of Schüco SI82 Classic

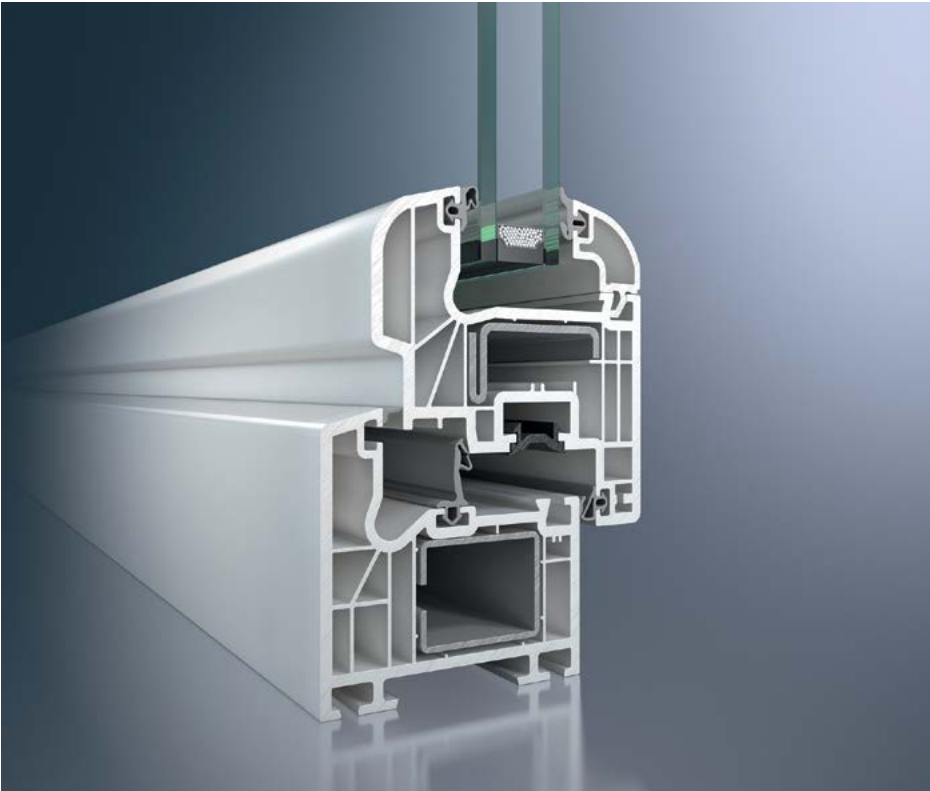

Schüco CT70 MD Rondo

With high thermal insulation and versatile accessories, Schüco CT70 has timeless lines, narrow face widths and very effective sound reduction.

When selecting uPVC window systems, you look for quality, design and innovation. The Schüco uPVC window systems combine these features in a diverse product range, offering architects a great degree of design flexibility. The CT70 window system with a 70 mm basic depth is the ideal choice for well insulated double-pane or triple-pane applications.

uPVC systems with a basic depth of 70 mm achieve high thermal insulation values with the narrowest of face widths. These profile systems are the perfect answer to rising energy costs and stringent environmental protection demands.

Schüco CT70 is available as a rebate gasket system with two drainage levels (AS) and also as a center gasket system with an additional third drainage level (MD).

Top Double-Pane Window

CT70 is currently the best double-pane uPVC window on the market. Combined with R-6 glass, it provides performance that rivals triple-pane performance from US window manufacturers.

Affordable R-5 Performance

CT70 is one of the most affordable window products with R-6 center-of-glass (COG) performance. This makes it an excellent choice for projects that seek better energy performance at the lowest possible cost.

Premium Finish Options

Our uPVC windows are available in a wide selection of woodgrain and single color decorative foils. Our RAL-certified, high quality decorative foils are weather-resistant, fade-resistant and have been successfully used for decades.



Winchester Finish

Simulated Divided Lites

Unparalleled double-pane performance makes CT70 a great choice for projects requiring simulated divided lites. SDL muntins can be awkward with triple-pane glass. CT70 enables architects to achieve peak energy performance without aesthetic compromises with SDLs in triple-pane glass.

Schüco CT70

Great Thermal Insulation at an Excellent Price

Energy

- Profile construction with optimized chamber geometry and a basic frame depth of 70 mm for excellent thermal insulation
- U_f values from 1.2 to 1.5 W/(m²K)
- Vent overlap of 8 mm minimizes heat loss
- Glass edge cover of 18 mm guarantees minimal heat loss in the glass edge seal area
- Triple glazing with a glass thickness of up to 52 mm possible

Design

- Vent profiles are available in three different contours (Classic, Rondo, Cava)
- Narrow face width of 120 mm (standard profile combination) highlights the window's slim-lined look
- Various glazing bead contours as a design feature
- White profiles are supplied with modern, silver-grey gaskets, foiled profiles with black gaskets as standard
- The flush fitting gaskets blend in perfectly with the appearance of the window
- Profiles can be colored with a large selection of wood grains and single color decorative foils
- A comprehensive range of aluminum cover caps is available for integration in aluminum façades

Security

- Depending on structural requirements, various reinforcing profiles in the outer and vent frames ensure that the windows are highly robust and durable.
- Special screw ports for fixing the corner pivot in the vent
- Fittings axis of 13 mm allows the use of burglar-resistant hardware

Comfort

- Narrow face widths ensure maximum light penetration
- Excellent sound reduction values (depending on the profile combination and glazing, sound insulation values up to $R_{w,p}$ 48 dB are possible)

- Smooth outer-frame rebate and flush glazing bead makes the windows easy to clean
- Gasket clearance of 5 mm ensures the windows close smoothly

Parameters	
Frame depth	82 mm 3.23 in
Frame face width	120 mm 4.72 in
Possible glazing thickness	6 - 52 mm 0.24 - 2.05 in
Thermal insulation U_f	1.2 - 1.5 W/(m ² .K) 0.21 - 0.26 Btu/(hr. ft ² .°F)
Sound insulation $R_{w,p}$	46 - 48 dB

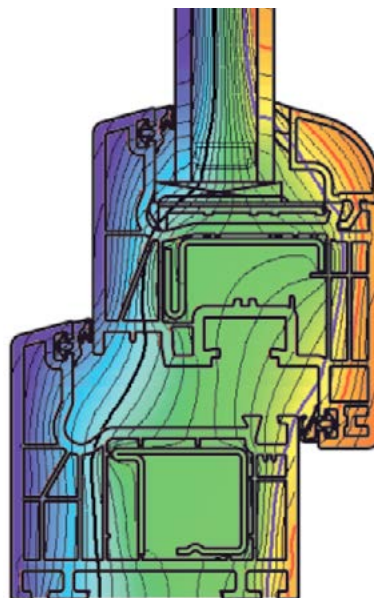

Isothermal flow in Schüco CT70 AS Classic

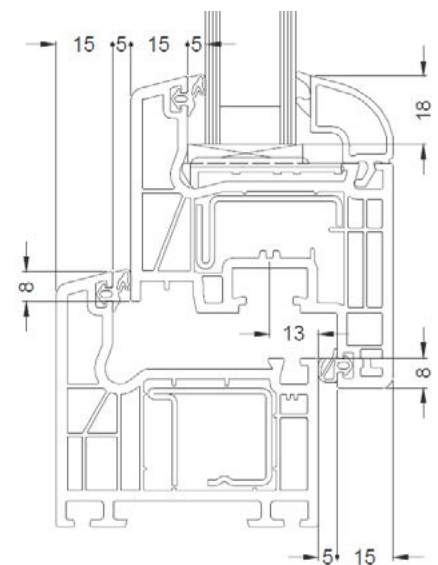

Section detail of Schüco CT70 AS Classic

Schüco uPVC Doors

Entry, Patio and Sliding Door Systems



Schüco SI82 Entry and Patio Doors

The Schüco SI82 door system is available for both single-sash entry doors and double-sash patio doors.

Features and Benefits

- 5-chamber profile system with a basic depth of 82 mm
- Narrow face widths
- Excellent thermal insulation through thermal break in threshold area
- Increased basic depth for more security and protection against break-ins
- Three drainage levels for optimum protection against wind, rain and noise
- Concealed drainage



Schüco Tilt-Slide Doors

Tilt-slide doors combine the benefits of slide and tilt-turn functions: the door units "float" on ball-bearing rollers and are very easy to open and close. Unlike standard lift-slide doors, they can also be tilted.

Schüco tilt-slide doors are the most airtight sliding doors on the market, suitable for Passive House applications. In addition, they offer the highest levels of noise reduction because of their excellent sealing qualities.



Schüco ThermoSlide

The Schüco ThermoSlide uPVC lift-and-slide door makes a bold design statement, while at the same time flooding rooms with light and creating attractive views. Its space-saving design allows designers to create dramatic interiors.

Our emphasis on energy efficiency is not only about protecting our environment but also about reducing energy costs. With sophisticated uPVC multi-chamber profiles, a basic depth of 82 mm and high-quality triple insulating glass, Schüco ThermoSlide achieves outstanding thermal insulation values up to Passive House standard ($U_w \leq 0.8 \text{ W}/(\text{m}^2\cdot\text{K})$). This creates a high level of comfort in your home while cutting down on energy costs.



Schüco SI82 Door



Schüco CT70 Tilt-Slide Door

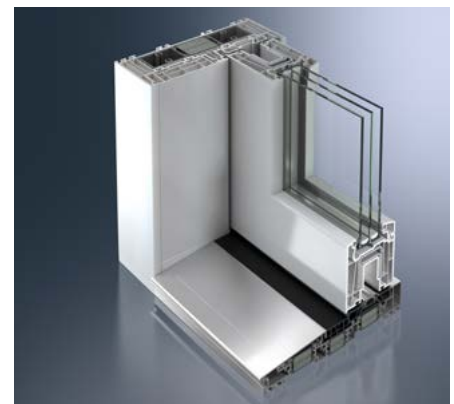

Schüco ThermoSlide Lift-Slide Door

Wood

products

Makrowin MW88 G2 | 21

PHI Certified Triple-Pane Window



Makrowin MW88 | 23

PH Performance Triple-Pane Window



Makrowin MW78 | 25

Top Performance Double-Pane Window



Makrowin MW AluClad | 27

Premium Aluminum Clad Windows



Makrowin MW Doors | 29

Entry, Patio, Lift-Slide & Tilt-Slide Doors



Lakes Region, NH Residence

Design: Moskow Linn Architects
MacArthur Construction Co.

Product:

Makrowin MW78 Wood Windows
Glass: R-5 Double-Pane



Makrowin MW88 G2

As the most recent addition to our Passive House fenestration offering, the MW88 G2 window represents the state-of-the-art in engineered wood frame technology. This window was recently certified at the Passivhaus Institute (PHI) in Darmstadt, achieving $U_f = 0.13 \text{ Btu}/(\text{hr}\cdot\text{ft}^2 \cdot ^\circ\text{F})$. At 88 mm thickness, this window profile represents the thinnest PHI-certified wood window design.

The annual heating demand in an energy efficient passive house is limited to 15kWh/m² or 4.75 kBtu/ft². The requirements on window frames suitable for passive houses are extremely strict. Heat loss in such houses during the coldest days of the year is estimated at 1.4 to 1.6 kW. Considering how small this value is, a single heat recovery ventilation system with a small heating element is sufficient to provide thermal comfort in such buildings.

PHI Certified Product

Our highest performing wood window frame certified by the Passivhaus Institute in Darmstadt achieving $U_f=0.13 \text{ Btu}/(\text{hr}\cdot\text{ft}^2 \cdot ^\circ\text{F})$.

Strongest Insulated Frame

Insulation can compromise the strength of PH window frames. Structural integrity was of paramount importance when designing the MW88 G2 frame. Our goal was to create a Passive House window that can handle large panes of heavy glass for years of trouble-free operation.

Glass Up to R-14, SHGC to 0.62

Partnering with Saint Gobain Glass, we use the most innovative glass substrates in the world. Our triple-pane glass reaches up to R-14 and SHGC=0.62, giving PH designers greater flexibility when modeling projects in PHPP.

Premium Aluminum Cladding

MW88 G2 is available with the option of aluminum cladding on the exterior making the windows virtually maintenance free. No thin sheet metal used; our cladding is 100% extruded and all corners are welded for years of watertight protection.

Certificate
 Certified Passive House component
 for cool, temperate climate, valid until 31.12.2015

Category: Window Frame
 Manufacturer: Makrowin s.r.o.
 Product name: 962 12 Derva, SLOWAKIA
 MAKROWIN 88 G2

The following comfort criteria were used in awarding this certificate:

Given a U_g value of 0.70 W/(m²K) and a window size of 1.23 m by 1.48 m,
 $U_{w,e} = 0.79 \text{ W/(m}^2\text{K)} \leq 0.80 \text{ W/(m}^2\text{K)}$

Taking into account the installation based thermal bridges, and provided that the installation is, with regard to the thermal bridges, equal or better than shown in the data sheet, the window meets the following criterion:
 $U_{w,thermal} \leq 0.05 \text{ W/(m}^2\text{K)}$

Thermal data of the window frame

Spacer	U-value [W/(m ² K)]	Width [mm]	Ψ_{sp} [W/(m ² K)]	$f_{sp,0.25}$ [1]
Bottom	0.80	151	0.031	0.80
Side/top	0.75	131	0.020	

*Spacers of lower thermal quality, especially those made of aluminum, lead to significantly higher thermal losses and lower temperature factors.

Further information see data sheet
www.passivehouse.com 0063w03

Passive House Institute
 Dr. Wolfgang Feist
 64283 Darmstadt
 GERMANY

Passive House Efficiency Class

pA
pB
pC

CERTIFIED COMPONENT
 by the Passive House Institute

SCHÜCO

**North American Distributor
 of Fine European Windows**

Makrowin MW88 G2 Passive House Certified Wood Window

Design

- Frame profiles can be manufactured from a variety of wood species, including clear spruce, clear pine, oak, mahogany, and European larch, with a wide selection of finishes
- Three-step factory finishing system surpassing any finish applied on the job site
- Both the frame and sash include thermal break layers of cork, a natural material with great sound, thermal and anti-vibration properties
- Narrow face width of 131 mm highlights the slim-lined look of the window
- Soft-line contours with radii of 8 mm contribute to a timeless look and improve adhesion of the finishing layers
- Sloping exposed faces and aluminum drip edges protect the surfaces that would otherwise be vulnerable to ice and water damage
- Pre-finished glazing stop on the interior side with the invisible pins concealed under the seal
- Glazing ventilation removes moisture that may condense around the perimeter of the glazing
- Decompression groove prevents penetration of water and air between the glazing bead and the glazing

Energy Efficiency

- Wood profile construction with thermal break and basic frame depth of 88 mm for excellent thermal insulation
- U_f value of 0.773 W/(m²K) for jamb and head profiles and 0.826 W/(m²K) for sill
- Vent overlap of 6 mm minimizes heat loss
- Glass edge cover of more than 20 mm guarantees minimal heat loss in the glass edge seal area
- Triple glazing with a glass thickness of 44 mm

Security

- Compact geometry of the frame ensures that the windows are highly robust and durable
- Fitting groove secures engagement of the locking elements along the perimeter of the window
- All hardware components are protected from corrosion and against dirt by the outer-frame rebate gasket

Comfort

- Narrow face widths ensure maximum light penetration
- Excellent sound reduction values
- Flush glazing bead makes the windows easy to clean
- Gasket clearance of 5 mm ensures the windows close smoothly

Parameters	
Frame depth	88 mm 3.46 in
Frame width (sill/head/jamb)	151 / 131 / 131 mm 5.94 / 5.15 / 5.15 in
Possible glazing thickness	44 mm 1.73 in
Thermal insulation U_f	0.773 W/(m ² .K) 0.132 Btu/(hr.ft ² .°F)
Thermal bridge coefficient Ψ_{spacer}	0.030 W/(m.K) 0.017 Btu/(hr.ft.°F)

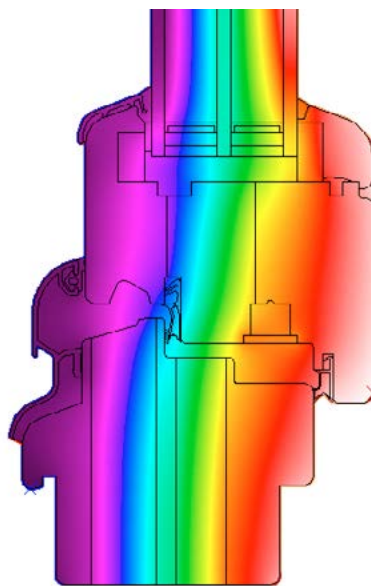

Isothermal flow in MW88 G2

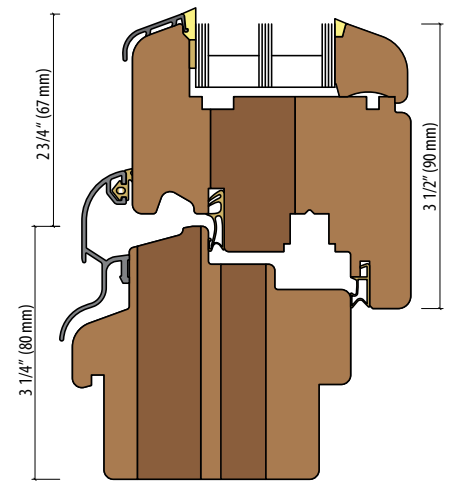

Vertical section of sill in MW88 G2



Makrowin MW88

Makrowin produces some of the most energy efficient wood windows in Europe. MW88 is their most widely used window frame for applications utilizing high-performance triple-pane glass. At 88 mm deep, the sash frame is capable of utilizing insulated glass up to R-14, enabling the frame to achieve PH-level U_w values. The sash and frame are exceptionally strong, making them suitable for extra large window assemblies up to 8 ft in height.

Focus on Quality

Manufacturing of wood windows requires a continuous focus on quality at every stage of production. Attention to detail is critical when selecting wood materials, assembling window frames and preparing them for finishing. Makrowin demonstrates the highest quality of craftsmanship in every window that they make. Their products are completely finished prior to glazing, assuring long life for the sash and frame. The company employs expert finishers to give their windows a long-lasting, furniture-like finish.

Cladding Options

Makrowin windows are available with exterior aluminum cladding, providing the window frame with decades of protection from rain, ice and harmful UV radiation. The aluminum cladding is available in a wide range of RAL colors, starting with a basic palette of 26 colors and 210 premium color options.

Matching Insect Screens

Makrowin also offers aluminum insect screens in matching RAL color options. The screens clip directly to the window frame, providing for easy installation and removal.

Passive House Performance

Combined with R-10 triple-pane glass, MW88 is capable of achieving Passive House performance metrics with an all-wood frame, making for a more affordable PH wood window option. The added strength of all-wood frames enables the use of even larger operable window openings up to 8ft in height.

Glass up to R-14, SHGC 0.62

Partnering with Saint Gobain Glass, we use the most innovative glass substrates in the world. Our triple-pane glass reaches up to R-14 and SHGC=0.62, giving PH designers greater flexibility when modeling projects in PHPP.

Professional Wood Finish

Europeans rely on window manufacturers for long-lasting wood finishes. Our wood frames receive a 3-coat professionally applied finish under controlled conditions. No painting contractor can replicate such a finish at the jobsite. Our acrylic polymer wood finishes perform beyond the four- to seven-year expected lifetime of conventionally painted windows, and our 10-year customers can prove it.

Premium Aluminum Cladding

MW88 is available with the option of aluminum cladding on the exterior, making the windows virtually maintenance free. No thin sheet metal is used; our cladding is 100% extruded and all corners are welded for years of water-tight protection.



North American Distributor
of Fine European Windows



Makrowin MW88 Triple-Pane Wood Window with PH Performance

Design

- Frame profiles can be manufactured from a variety of wood species including clear spruce, clear pine, oak, mahogany, and European larch, with a wide selection of finishes
- Three-step factory finishing system surpassing any finish applied on the job site
- Narrow face width of 119 mm highlights the slim-lined look of the window
- Soft-line contours contribute to a timeless look and improve adhesion of the finishing layers
- Sloping exposed faces and aluminum drip edges protect the surfaces that would otherwise be vulnerable to ice and water damage
- Pre-finished glazing stop on the interior side with the invisible pins concealed under the seal
- Glazing ventilation removes moisture that may condense around the perimeter of the glazing
- Decompression groove prevents penetration of water and air between the glazing bead and the glazing

- Fitting groove secures flawless engagement of the locking element tips along the whole perimeter of the window
- All hardware components are protected from corrosion and against dirt by the outer-frame rebate gasket

Comfort

- Narrow face widths ensure maximum light penetration
- Excellent sound reduction values
- Flush glazing bead makes the windows easy to clean
- Gasket clearance of 5 mm ensures the windows close smoothly

Energy Efficiency

- Wood profile construction and basic frame depth of 88 mm for excellent thermal insulation
- U_f value of 1.014 W/(m²K) for jamb and head profiles and 1.125 W/(m²K) for sill
- Vent overlap of 6 mm minimizes heat loss
- Glass edge cover of more than 20 mm guarantees minimal heat loss in the glass edge seal area
- Triple glazing with a glass thickness of 44 mm

Security

- Compact geometry of the frame ensures that the windows are highly robust and durable

Parameters	
Frame depth	88 mm 3.46 in
Frame width (sill/head/jamb)	137 / 119 / 119 mm 5.39 / 4.69 / 4.69 in
Possible glazing thickness	44 mm 1.73 in
Thermal insulation U_f	1.014 W/(m ² .K) 0.173 Btu/(hr.ft ² .°F)
Thermal bridge coefficient Ψ_{spacer}	0.030 W/(m.K) 0.017 Btu/(hr.ft.°F)

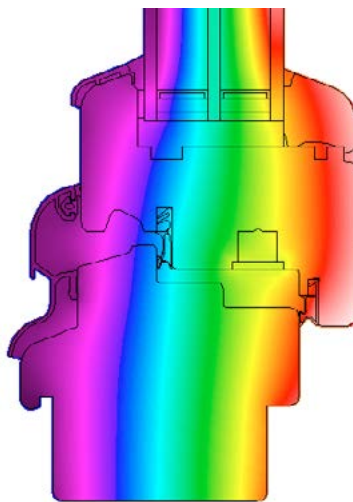

Isothermal flow in MW88

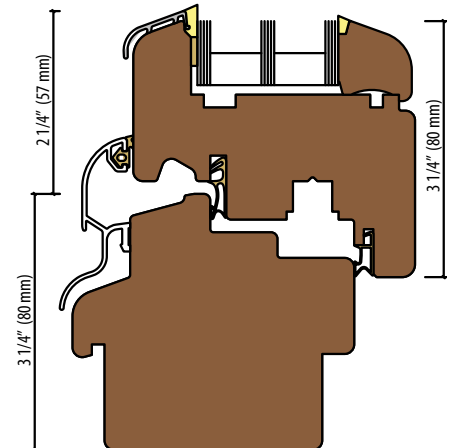

Vertical section of sill in MW88

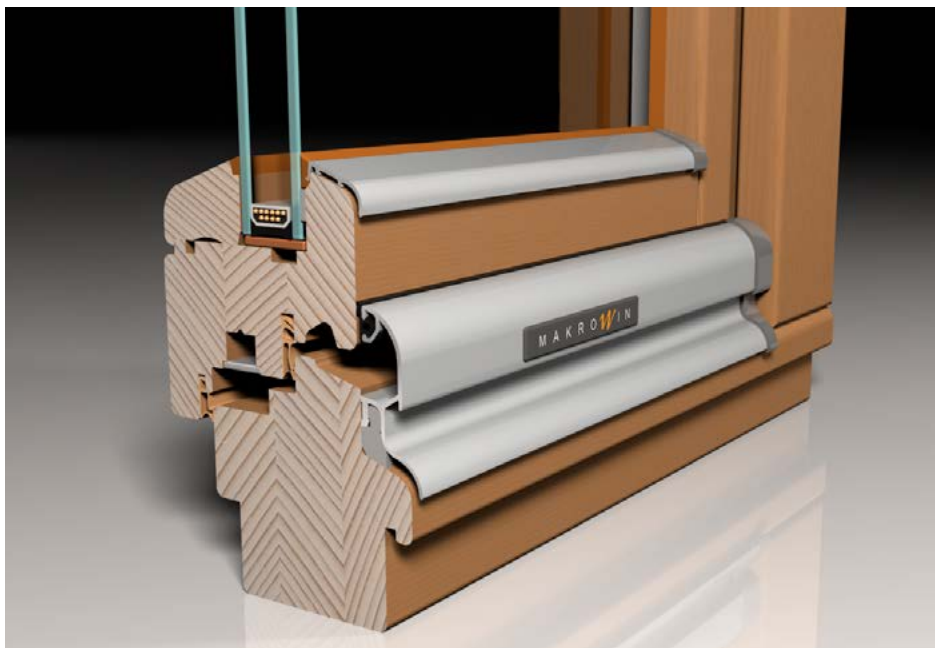

Makrowin MW78

Makrowin produces some of the most energy efficient wood windows in Europe. MW78 is their most widely used window frame for applications utilizing high-performance double-pane glass. At 78 mm depth, the sash frame is capable of utilizing insulated glass up to R-6, enabling the frame to achieve top energy performance metrics in the double-pane category. The sash and frame are exceptionally strong, making them suitable for extra large window assemblies up to 8ft in height.

Focus on Quality

The manufacturing of wood windows requires continuous focus on quality at every stage of production. Attention to detail is critical when selecting wood materials, assembling window frames and preparing them for finishing. Makrowin demonstrates the highest quality of craftsmanship in every window they make. Their products are completely finished prior to glazing, assuring long life for the sash and frame. The company employs expert finishers to give their windows a long-lasting furniture-like finish.

Cladding Options

Makrowin windows are available with exterior aluminum cladding, providing the window frame with decades of protection from rain, ice and harmful UV radiation. The aluminum cladding is available in a wide range of RAL colors, starting with a basic palette of 26 colors and 210 premium color options.

Matching Insect Screens

Makrowin also offers aluminum insect screens in matching RAL color options. The screens clip directly to the window frame, providing for easy installation and removal.

Top Double-Pane Performance

MW78 is currently the best double-pane wood window on the market. Combined with R-6 glass, it provides performance that rivals triple-pane performance from US window manufacturers.

Simulated Divided Lites

Unparalleled double-pane performance makes MW78 a great choice for historically sensitive projects requiring simulated divided lites. SDL muntins can be awkward with triple-pane glass. MW78 enables architects to achieve peak energy performance without aesthetic compromises with SDLs in triple-pane glass.

Professional Wood Finish

Europeans rely on window manufacturers for long-lasting wood finishes. Our wood frames receive a 3-coat professionally applied finish under controlled conditions. No painting contractor can replicate such a finish at the jobsite. Our acrylic polymer wood finishes perform beyond the 4-7yr expected lifetime of conventionally painted windows and we have 10-year customers to prove it.

Premium Aluminum Cladding

MW78 is available with the option of aluminum cladding on the exterior, making the windows virtually maintenance free. No thin sheet metal used; our cladding is 100% extruded and all corners are welded for years of watertight protection.

SCHÜCO

North American Distributor
of Fine European Windows

MAKROWIN®

Makrowin MW78 Top Double-Pane Wood Window

Design

- Frame profiles can be manufactured from a variety of wood species including clear spruce, clear pine, oak, mahogany, and European larch, with a wide selection of finishes
- Three-step factory finishing system surpassing any finish applied on the job site
- Narrow face width of 140 mm highlights the slim-lined look of the window
- Soft-line contours contribute to a timeless look and improve adhesion of the finishing layers
- Sloping exposed faces and aluminum drip edges protect the surfaces that would otherwise be vulnerable to ice and water damage
- Pre-finished glazing stop on the interior side with the invisible pins concealed under the seal
- Glazing ventilation removes moisture that may condense around the perimeter of the glazing
- Decompression groove prevents penetration of water and air between the glazing bead and the glazing

Energy Efficiency

- Wood profile construction with thermal break and basic frame depth of 78 mm for excellent thermal insulation
- U_f value of 1.212 W/(m²K) for jamb and head profiles and 1.407 W/(m²K) for sill
- Vent overlap of 6 mm minimizes heat loss
- Glass edge cover of more than 20 mm guarantees minimal heat loss in the glass edge seal area
- Double glazing with glass thickness of 26 mm and triple glazing with a glass thickness of 36 mm

Security

- Compact geometry of the frame ensures that the windows are highly robust and durable
- Fitting groove secures flawless engagement of the locking element tips along the whole perimeter of the window
- All hardware components are protected from corrosion and against dirt by the outer-frame rebate gasket

Comfort

- Narrow face widths ensure maximum light penetration
- Excellent sound reduction values
- Flush glazing bead makes the windows easy to clean
- Gasket clearance of 5 mm ensures the windows close smoothly

Parameters	
Frame depth	78 mm 3.07 in
Frame width (sill/head/jamb)	137 / 119 / 119 mm 5.39 / 5.15 / 5.15 in
Possible glazing thickness	26, 36 mm 1.02, 1.41 in
Thermal insulation U_f	1.212 W/(m ² K) 0.207 Btu/(hr.ft ² .°F)

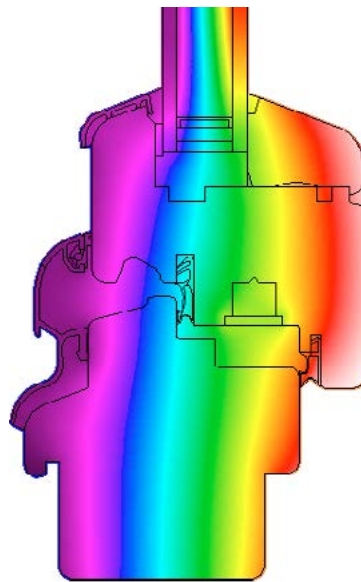

Isothermal flow in MW78

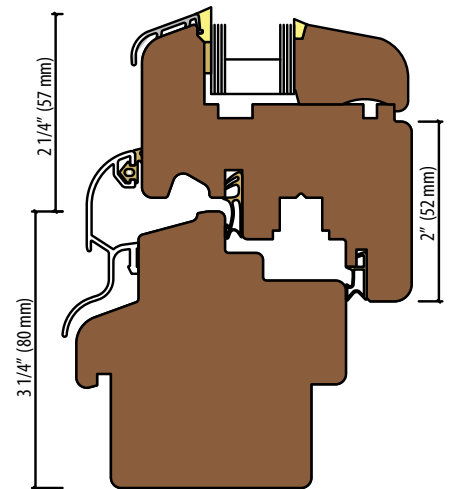

Vertical section of sill in MW78

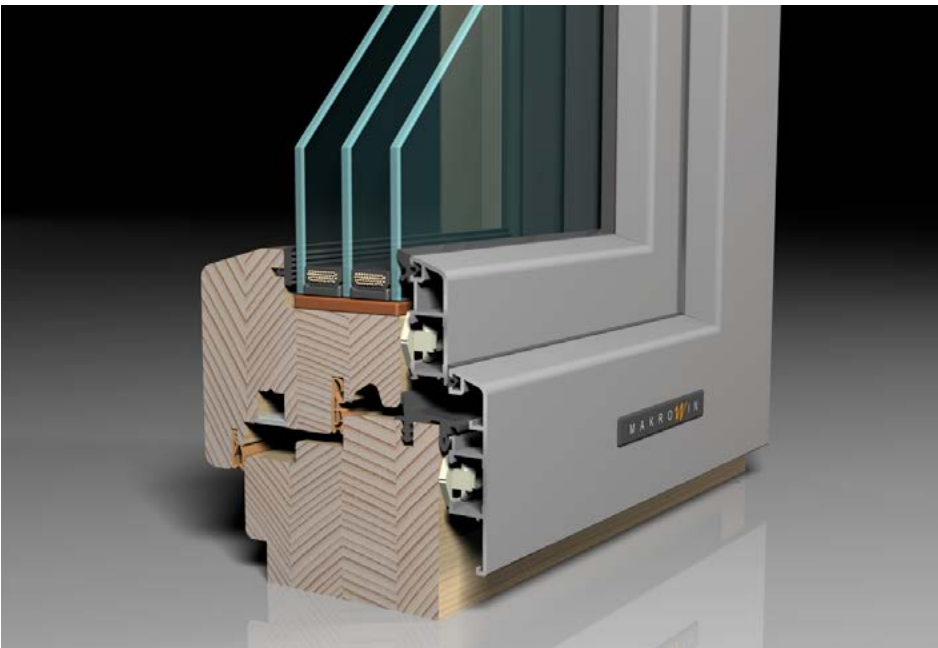

Makrowin MW88 Classic Alu-Clad

For demanding customers who desire the rich warm texture of wood on the inside and the durability of aluminum on the outside, these outstanding windows offer uncompromising performance and beautiful styling.

The aluminum cladding provides the window frame with decades of protection from rain, ice and harmful UV radiation. Our aluminum frames are of the absolute best quality available. We utilize 100% extruded materials, we weld all mitered corners and use the highest quality powder-coated finishes.

Color Flexibility

Tired of choosing windows from a set of eight manufacturer's color options? The Makrowin aluminum cladding is available in a wide range of RAL colors, starting with a basic palette of 26 colors and 210 premium color options.

Matching Insect Screens

Makrowin also offers aluminum insect screens in matching RAL color options. The screens clip directly to the window frame providing for easy installation and removal.

Premium Alu-Cladding

MW78 is available with the option of aluminum cladding on the exterior, making the windows virtually maintenance free. No thin sheet metal used; our cladding is 100% extruded and all corners are welded for years of water-tight protection.

100% Welded Corners

Our competitors import windows with mitered aluminum corners. This exposes aluminum cuts to corrosion and provides for water infiltration behind the cladding. Our corners are welded, sanded and subsequently powder-coated as a complete cladding frame. This makes for durable cladding, providing our wood windows with years of water-tight protection.

Five Cladding Designs

Not everyone likes their cladding the same way. That is why we offer five different cladding designs. Use Classic or Retro for a traditional look or Quadrat or Integral for a sleek modern design.

Bronze Cladding

Bronze cladding is available for the most demanding customers. This is a favorite option for projects involving places of worship and historic restorations. The cladding is available in natural bronze and patina finishes.



North American Distributor
of Fine European Windows



Aluminum Cladding

The Ultimate Protection For Wood Windows

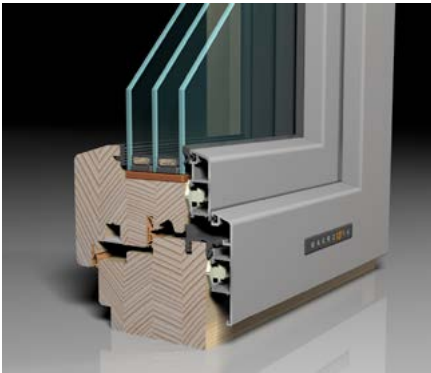

Makrowin MW88 Classic

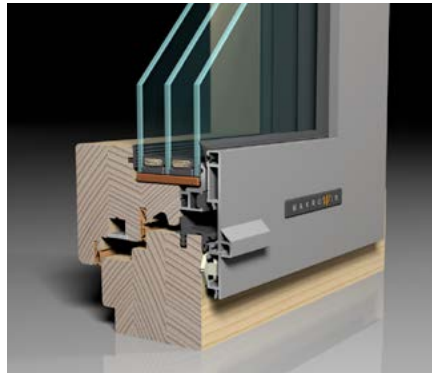

Makrowin MW88 Integral

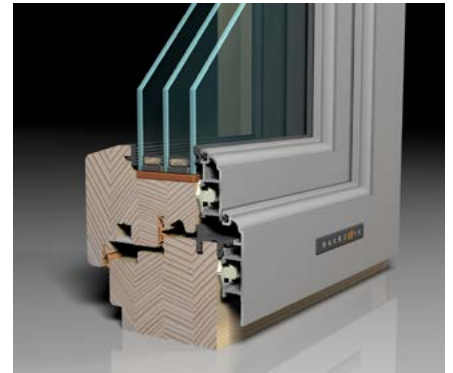

Makrowin MW88 Retro

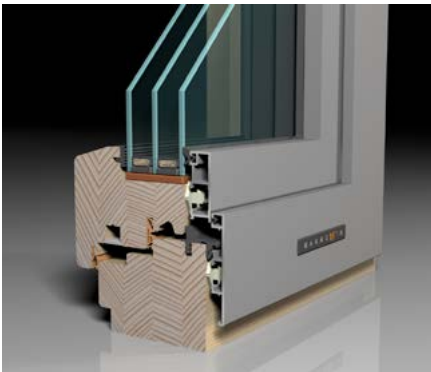

Makrowin MW88 Quadrat

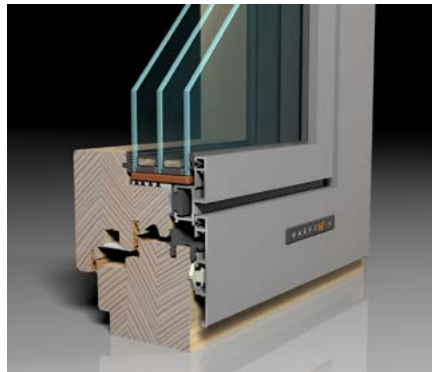

Makrowin MW88 Quadrat FB

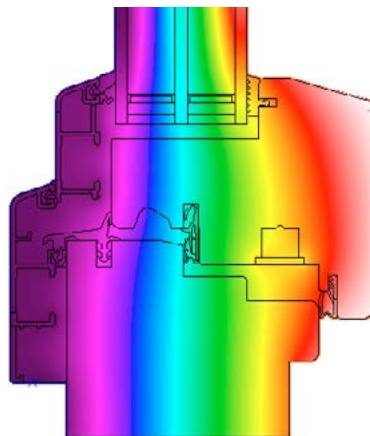

Isothermal flow in MW88 Classic

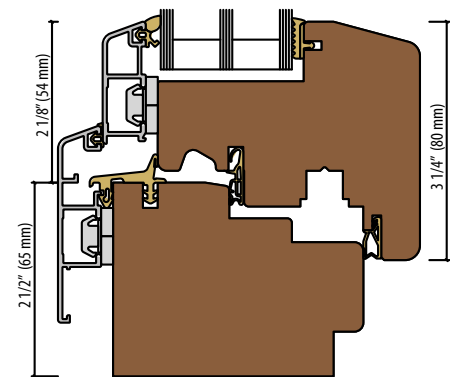

Vertical section of sill in MW88 Classic

Makrowin Wood Doors

Entry, Patio, Sliding and Folding Door Systems



Makrowin Entry Doors

Wood is often the preferred material for entry doors. We offer the highest quality wood entry doors on the market. Handcrafted from the finest materials and finished to perfection, these doors become the focal point on each of our projects.

In addition to their high aesthetic quality, our doors rank at the top of energy performance charts, making them a popular choice for Passive House designers. The thickness of the 88 mm sash and frame design enables the use of thick insulated panels for peak thermal performance.



Makrowin Lift-Slide Doors

Lift-slide hardware is the undisputed choice for top quality sliding door manufacturers. Capable of handling ultra large sashes, the system can be used to create openings in excess of 50 ft.

The lift-slide rollers enable easy operation of doors weighing hundreds of pounds. The up and down motion of the sash enables the door to sit tight on its dual gaskets, keeping water and drafts at bay. This creates a high level of comfort in your home and contributes to the overall energy efficiency of the door system.



Makrowin Tilt-Slide, Folding and Inswing Patio Doors

We offer a wide variety of wood patio doors: single and double-sash inswing patio doors, folding patio doors and tilt-slide doors.

Tilt-slide doors combine the benefits of slide and tilt-turn functions: the door units "float" on ball-bearing rollers and are extremely easy to open and close.

Multi-point perimeter hardware locks the sash on all four sides, providing for maximum security and air-tightness. Additionally, the sliding leaf is secured against being forced open when in the tilt position.

Multi-point locks provide for the most airtight door sashes on the market, making them suitable for Passive House applications.



Makrowin MW88 Entry Door with Insulated Panel

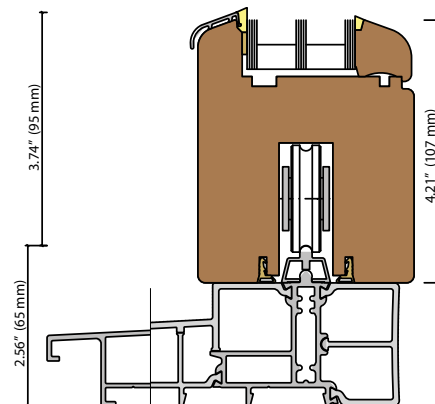

Makrowin MW88 Lift-Slide Door Section

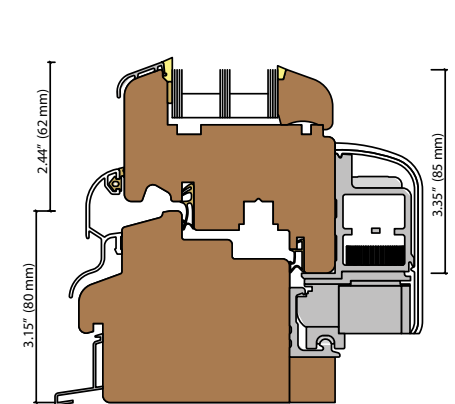

Makrowin MW88 Tilt-Slide Door Section

aluminum

products

Schüco AWS 90.SI+ | 31

PH Performance Triple-Pane Window



Schüco AWS 75.SI | 32

High Performance Triple-Pane Window

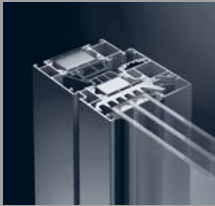

Schüco AWS 70.HI | 33

Best Value Double and Triple-Pane Windows



Schüco AWS 65 | 34

High Performance Double-Pane Window



Schüco ADS Doors | 35

Entry, Patio, Lift-Slide & Tilt-Slide Doors



Schüco Window AWS 90.SI+

Passive House Standard for Aluminum Window

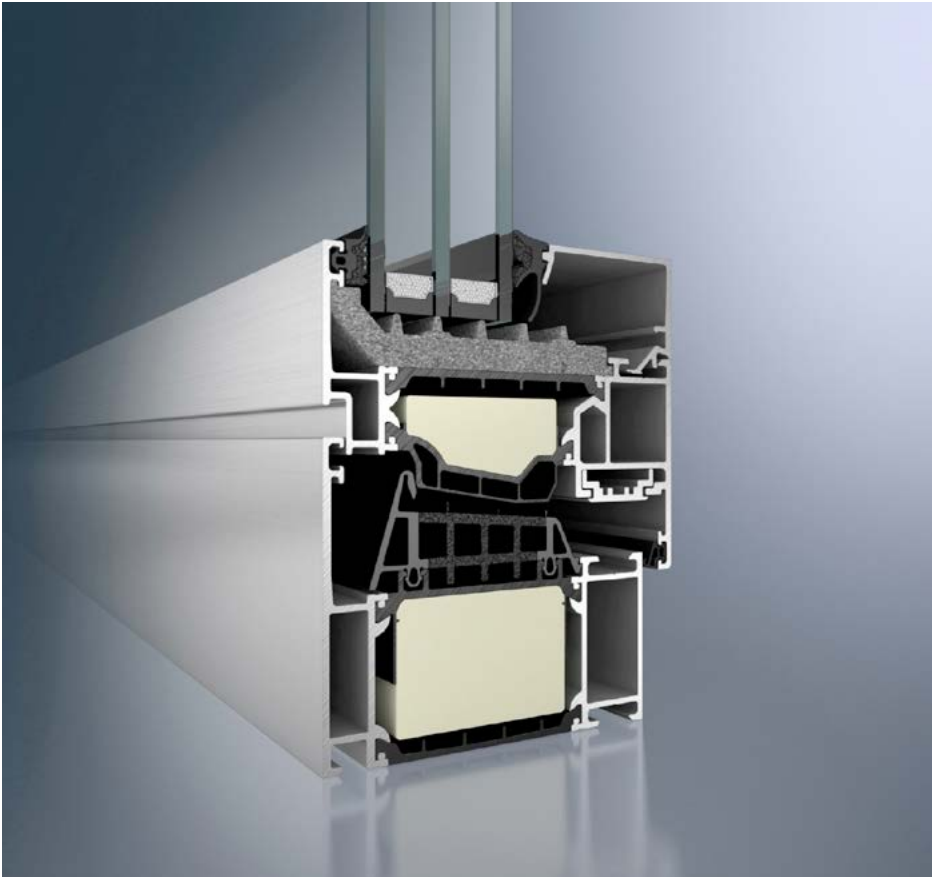

Schüco AWS 90.SI+

The Schüco AWS 90.SI+ aluminum window combines the benefits of aluminum with pioneering thermal insulation for sustainable architecture.

The Schüco AWS 90.SI+ window meets the demand for maximum thermal insulation previously restricted to uPVC and timber windows.

Combined with the concealed Schüco AvanTec hardware, sashes up to 350 lbs can be installed.

Features and Benefits

- Profile depth of 90 mm
- The maximum thermal insulation U_f value of $0.9 - 1.0 \text{ W}/(\text{m}^2\cdot\text{K})$
- Co-extruded center gasket with fins
- Optimized insulation zone with foam-filled insulating bars
- Available in a design with tilt-slide hardware
- Compatible with the Schüco ADS 90.SI door system



Isothermal flow in AWS 90.SI+

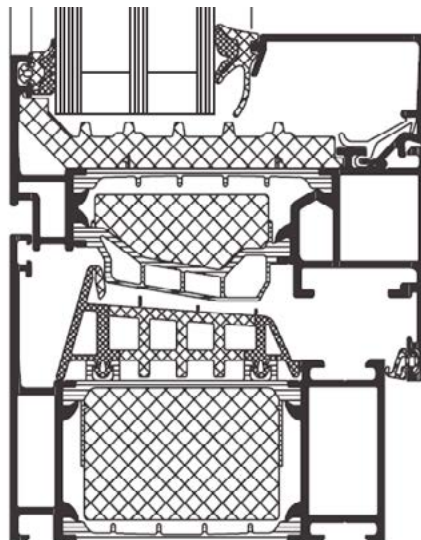

Section detail of AWS 90.SI+

Parameters	
Frame depth	90 mm 3.54 in
Frame face width	117 mm 4.61 in
Thermal insulation U_f	$1.0 \text{ W}/(\text{m}^2\cdot\text{K})$ $0.18 \text{ Btu}/(\text{hr}\cdot\text{ft}^2\cdot^\circ\text{F})$
Sound insulation $R_{w,p}$	48 dB

Schüco Window AWS 75.SI

High Performance Triple-Pane Aluminum Window

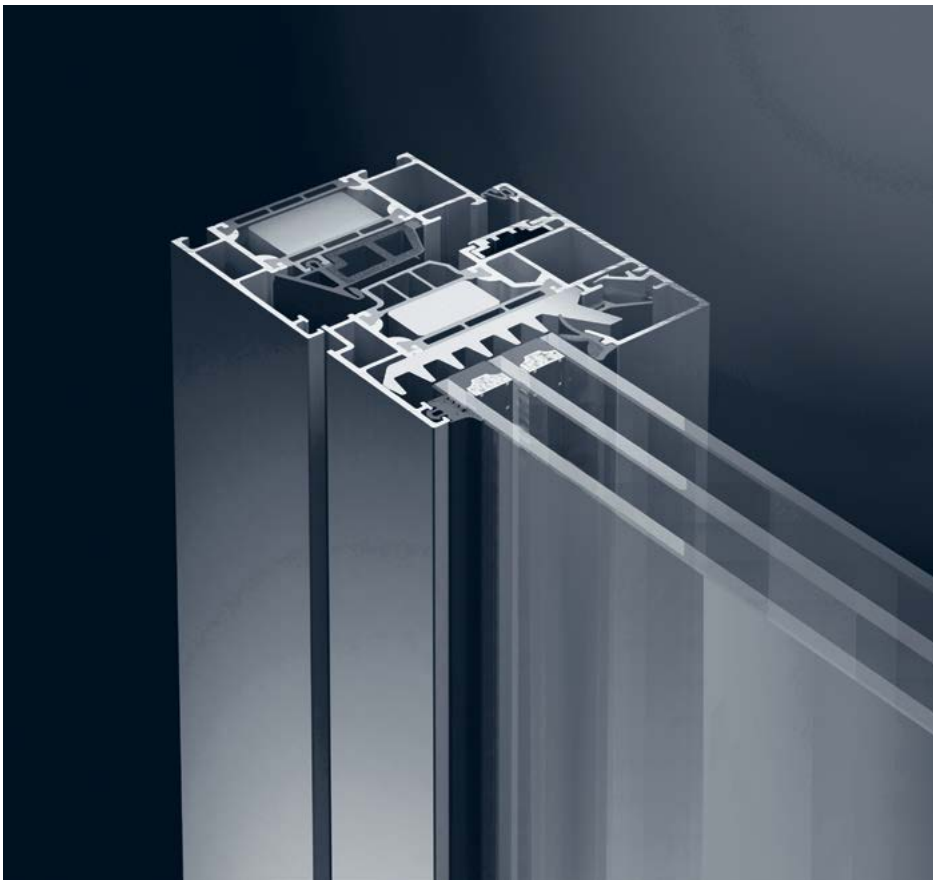

Schüco AWS 75.SI

The Schüco AWS 75.SI aluminum window system combines the excellent thermal insulation properties of uPVC and timber windows with the unique advantages of aluminum: durability and stability, narrow face widths and a variety of designs - in large, transparent formats.

With a basic depth of just 75 mm, this window system offers excellent versatility and can easily be combined with the Schüco ADS door system.

Features and Benefits

- Outstanding thermal insulation for basic depth of 75 mm: U_f values from 0.9 to 1.6 $W/(m^2.K)$
- Enlarged insulation zone with foam-filled insulating bars
- Optimized, co-extruded center gasket
- Innovative design of thermal insulation in glazing groove
- Wide range of profiles including the Schüco AWS 75 RL.SI design system
- Compatible with the Schüco ADS door series

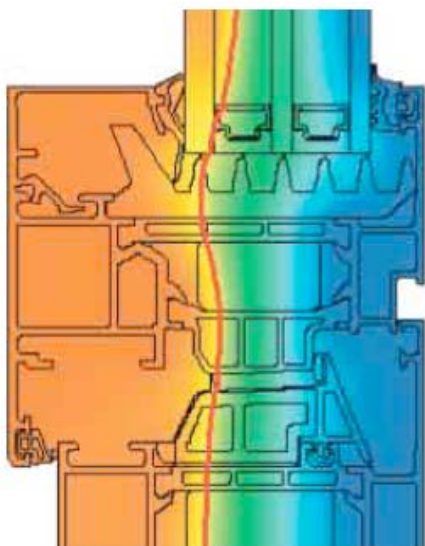

Isothermal flow in AWS 75.SI

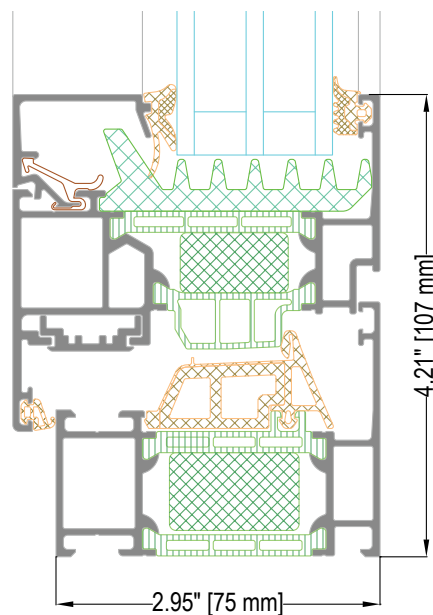

Section detail of AWS 75.SI

Parameters	
Frame depth	75 mm 2.95 in
Frame face width	117 mm 4.61 in
Thermal insulation U_f	1.3 $W/(m^2.K)$ 0.22 $Btu/(hr.ft^2.°F)$
Sound insulation $R_{w,p}$	48 dB

Schüco Window AWS 70.HI

Best Value Double and Triple-Pane Windows



Schüco AWS 70.HI

The Schüco AWS window systems with a basic depth of 70mm combine excellent thermal insulation with the unique advantages of aluminum: durability and stability, narrow face widths and a variety of designs.

In addition to the outward-opening solutions for easy-access window doors from the Schüco AWS 70.HI standard window series, there is a comprehensive range of options available with this basic depth, even for special design requirements.

Features and Benefits

- Excellent thermal insulation with a basic depth of 70 mm: U_f values of 1.6 W/(m².K) (face width 117 mm)
- Also available as outward-opening vent or as crank-operated, tilt-turn option for large, heavy units
- Compatible with the Schüco ADS door series

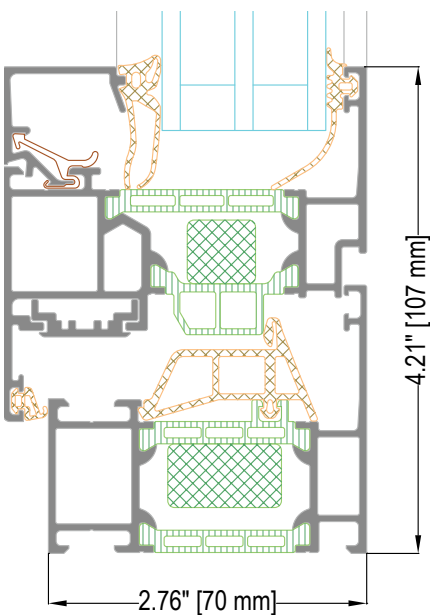

Section detail of AWS 70.HI

Parameters	
Frame depth	70 mm 2.76 in
Frame face width	117 mm 4.61 in
Thermal insulation U_f	1.6 W/(m ² .K) 0.27 Btu/(hr.ft ² .°F)
Sound insulation $R_{w,p}$	48 dB

Schüco Window AWS 65

Affordable Double-Pane Performance

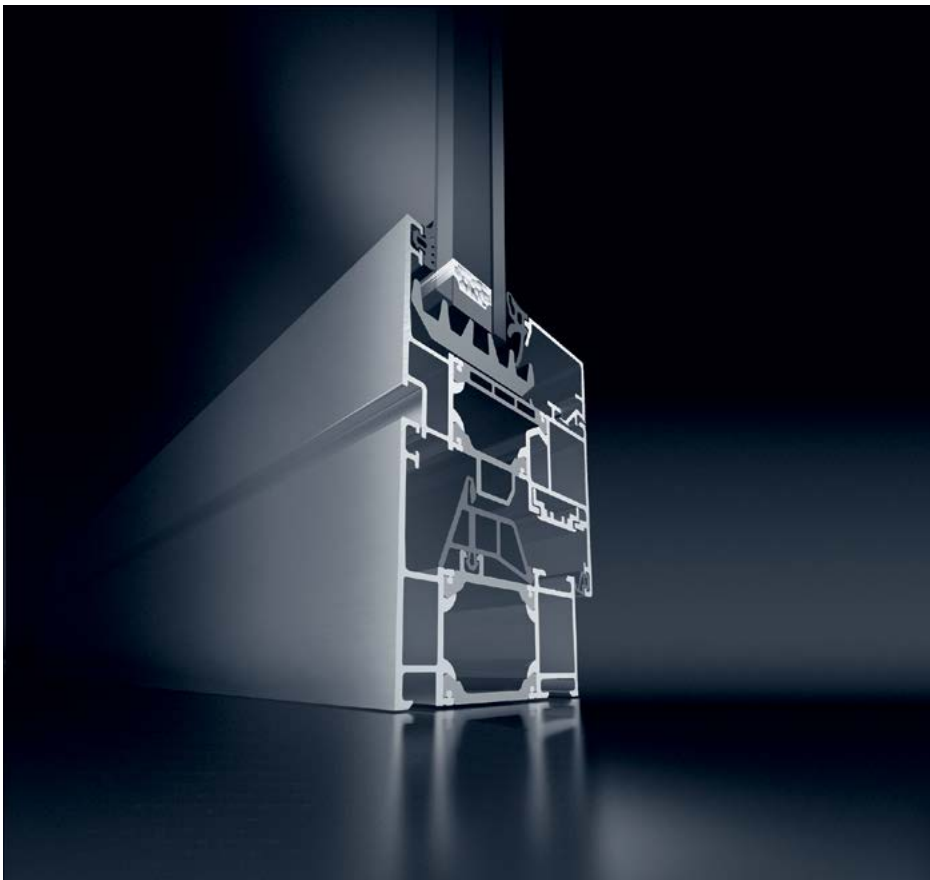

Schüco AWS 65

Schüco offers a high-performance, modern system with the Schüco AWS 65 window series. This system meets requirements for energy efficiency with a comprehensive range of profiles and carefully considered construction details.

Tailor-made solutions for inward and outward-opening windows are possible with the comprehensive Schüco AWS 65 standard window series.

Features and Benefits

- Improved thermal insulation with a basic depth of 65 mm: U_f values of $2.2 \text{ W}/(\text{m}^2\cdot\text{K})$ (face width 117 mm)
- Available as flush-fitted or outward-opening vent
- Available as a block system (BS) and window façade (WF), including an outward-opening solution
- Compatible with the Schüco ADS door series

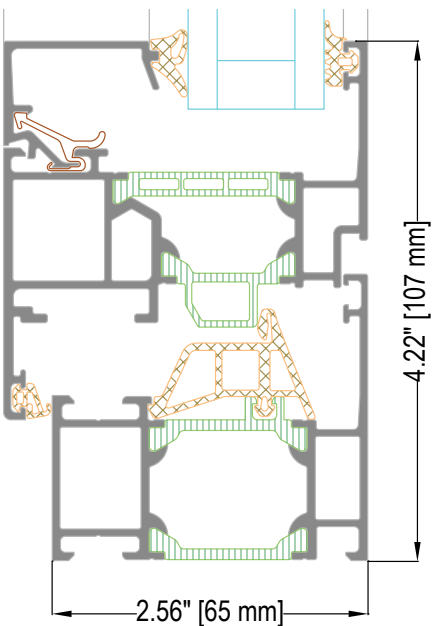

Section detail of AWS 65

Parameters	
Frame depth	65 mm 2.56 in
Frame face width	117 mm 4.61 in
Thermal insulation U_f	$2.2 \text{ W}/(\text{m}^2\cdot\text{K})$ $0.38 \text{ Btu}/(\text{hr}\cdot\text{ft}^2\cdot^\circ\text{F})$
Sound insulation $R_{w,p}$	47 dB

Schüco Aluminum Doors

Entry, Patio and Sliding Door Systems



Schüco ADS Entry and Patio Doors

The Schüco ADS 70, 75 and 90 entry and patio door systems offer high quality solutions for both residential and commercial applications. They combine exceptional water-tightness, excellent sound reduction and burglar-resistance with extremely easy operation.

The doors are available in both single and double-sash French door configurations. The patio door sash and frame profiles utilize multi-point hardware architecture compatible with the Schüco AWS window systems, providing designers with consistent sightlines between windows and doors.



Schüco ASS 70.HI Lift-Slide Doors

ASS 70.HI is the top performing aluminum lift-sliding system in the world. Capable of holding ultra large sashes, the profile can be used to create openings in excess of 50 ft.

The lift-slide rollers enable easy operation of doors weighing hundreds of pounds. The up and down motion of the sash enables the door to sit tight on its dual gaskets, keeping water and drafts at bay.

The door utilizes a profile with a wide thermal break, providing for exceptional energy performance.



Schüco Tilt-Slide Doors

Tilt-slide doors combine the benefits of slide and tilt-turn functions: the door units “float” on ball-bearing rollers and are extremely easy to open and close. Unlike standard lift-slide doors, they also can be tilted.

Schüco tilt-slide aluminum doors are the most air-tight sliding doors on the market, suitable for Passive House applications. In addition, they offer the highest levels of noise reduction because of their excellent sealing qualities.

Features and Benefits

- Compatible with profiles up to Schüco AWS 90.SI+ (90 mm depth)
- Up to 250 kg vent weight
- Large vents up to 2,200 mm x 2,800 mm possible
- Excellent weather-tightness



Schüco ADS 90.SI+ Entry Door



Schüco ASS 70.HI

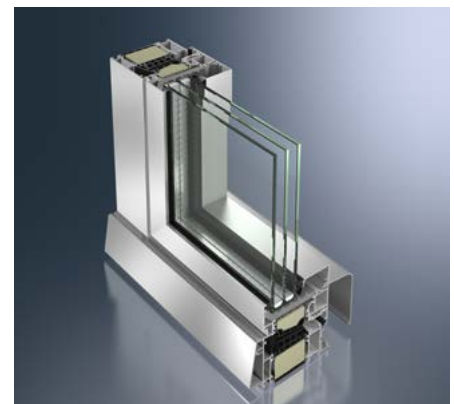

Schüco AWS 90.SI+ Tilt-Slide Door

Schüco ADS HD Commercial Doors

Heavy Duty Door Systems



Schüco ADS HD Commercial Doors

The Schüco ADS HD (Heavy Duty) door system is built to meet the requirements of large commercial projects and is optimized for continuous and maximum structural loading.

The ADS 90 system is capable of holding triple-pane glass up to R-14, enabling the doors to achieve an overall $U_g=0.17$ Btu/(hr.ft².F°). This makes ADS 90 a unique option for designers seeking Passive House or Net-Zero performance.

The Schüco ADS HD (Heavy Duty) door system is ideal for entrance areas subject to heavy use. Fitted with barrel hinges, the system is tested to 1 million cycles and therefore meets the highest durability requirements.

The ADS door system is available with ADA-compliant thresholds, panic bar hardware, coordinated door closers, electronic multi-point locks, and handicap-accessible openers, making it the most versatile commercial door on the market.



Schüco Fingerprint Access System



Schüco Panic Hardware



Schüco Heavy-Duty Hardware

curtain wall

products

Schüco FW50+.SI | 38

PHI Certified Aluminum Curtain Wall

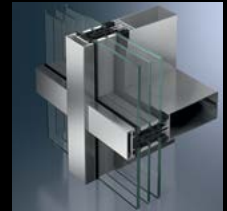

Makrowin MW50 | 39

PH Performance Wood Curtain Wall

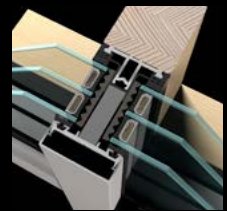

Cambridge, MA Residence

Design: Moskow Linn Architects
MacArthur Construction Co.

Product:

Schüco FW50+.SI Passive House Curtain Wall
Glass: R-10 Triple-Pane, SHGC 0.50

Schüco FW50+.SI Curtain Wall

Passive House Certified Aluminum Curtain Wall

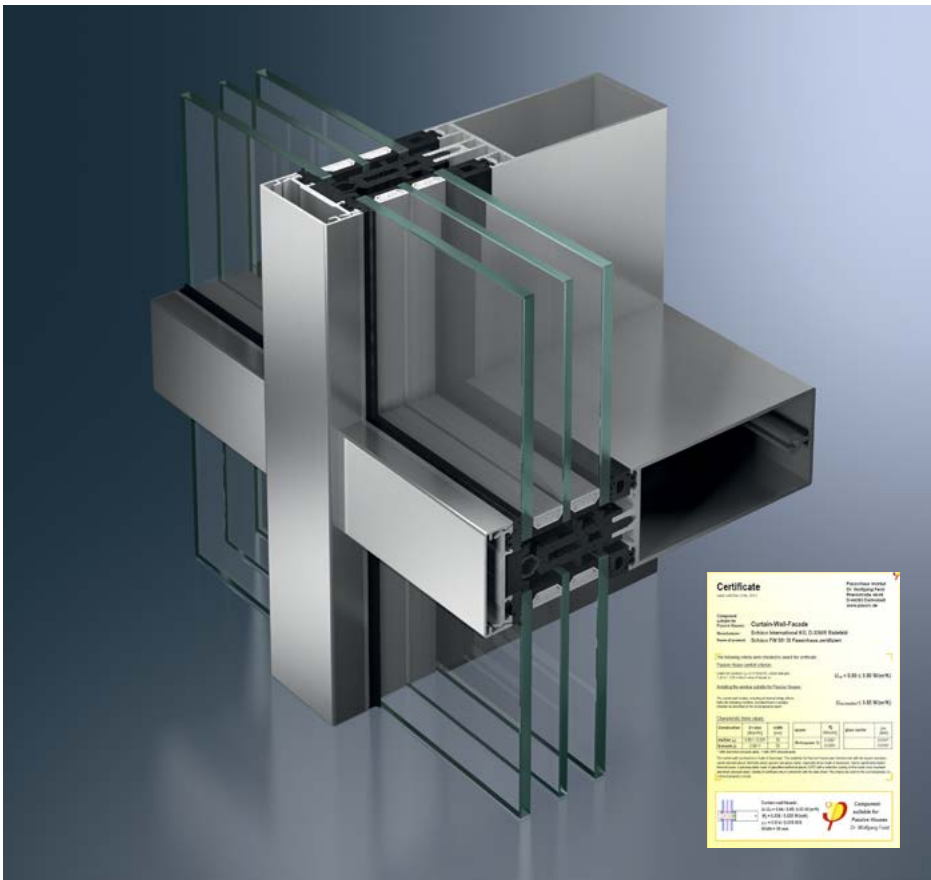

Schüco FW50+.SI with Passive House Certificate

The newly developed FW50+.SI (Super Insulated) version of the aluminum mullion/transom construction is the most efficient curtain wall system in the world.

The isolator design uses super-insulating materials to reduce thermal transfer via the frame. Inward-facing reflective surfaces on the pressure plates also contribute to the outstanding U_f value of up to $0.78 \text{ W}/(\text{m}^2\text{K})$, including the fasteners. The system achieves this value for the Passive House (PH) certified version with a glazing thickness of 48 mm.

As part of Passive House Institute (PHI) certification, the system meets the PH comfort criterion of $U_{cw} \leq 0.80 \text{ W}/(\text{m}^2\text{K})$ and satisfies the PH requirements with outstanding thermal insulation. The PHI calculated and certified the profile in accordance with the latest criteria for certifying façade systems, using triple insulating glazing ($U_g = 0.70 \text{ W}/(\text{m}^2\text{K})$) with a façade module of $1.20 \text{ m} \times 2.50 \text{ m}$. EAS offers the FW50+.SI system with glazing up to $U_g = 0.50 \text{ W}/(\text{m}^2\text{K})$, enabling PH designers to exceed the PHI performance standard and provide their clients with living spaces with more glazing area.

Glass Roofs and Skylights

The FW50+ curtain wall was designed for both vertical wall and overhead glass roof applications. The overhead curtain wall system is specifically designed for horizontal condensation management, snow-load strength and design flexibility. The FW50 mullions are available in depths from 85 mm to 250 mm (3.3 in - 10 in) to satisfy even the most demanding structural loads.



Schüco FW50 glass roof

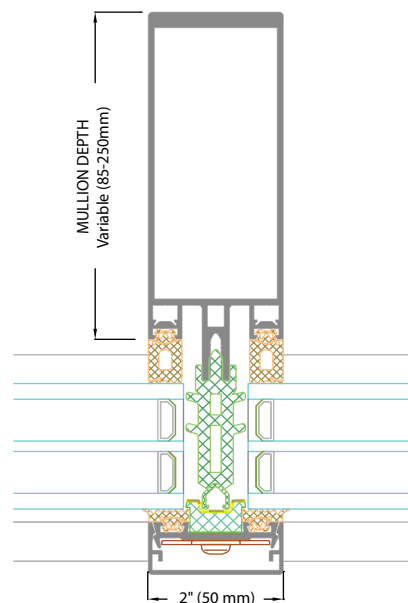

Section detail of FW50+.SI

Parameters	
Frame depth	85 - 250 mm 3.35 - 9.84 in
Frame face width	50 mm 2 in
Thermal insulation U_f	$0.78 \text{ W}/(\text{m}^2\text{K})$ $0.133 \text{ Btu}/(\text{hr}\cdot\text{ft}^2\cdot^\circ\text{F})$

Makrowin MW50 Curtain Wall

High Efficiency Wood/Aluminum Curtain Wall System

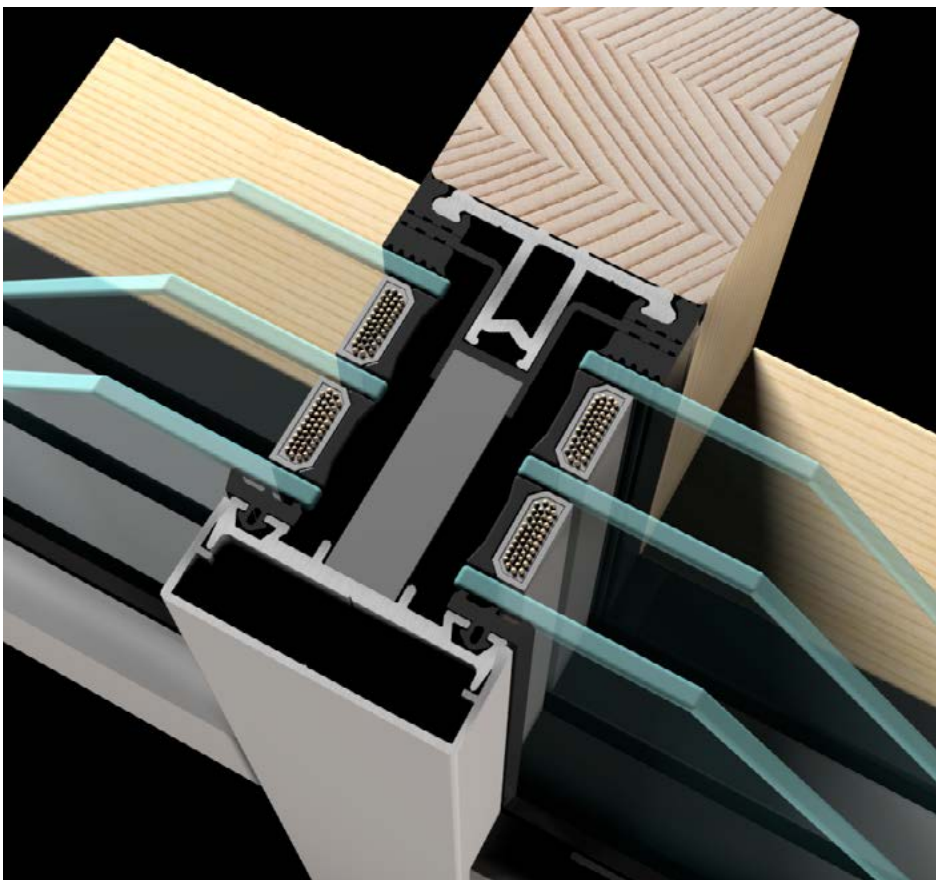

Makrowin MW50 Wood/Aluminum Curtain Wall



MW50 Curtain Wall with Natural Stain Finish

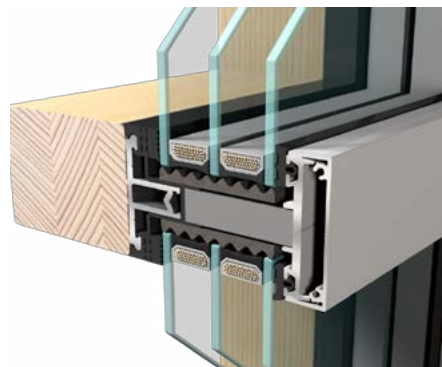

MW50 Horizontal Transom

The MW50 wood curtain wall is an excellent choice for architects who want to create large expanses of floor-to-ceiling glass while maintaining the warm look of natural wood. Handcrafted from multiple layers of top grade solid wood, the curtain wall mullions provide exceptional strength and dimensional stability.

The glazing bar utilizes the best designs inherited from the world of aluminum curtain walls. The isolator design uses super-insulating materials to reduce thermal transfer via the frame and virtually eliminates condensation near wood surfaces.

The MW50 mullions have a face width of 50 mm (2 in) and are available in various depths to satisfy the requirements of differing structural loads.

Glass up to R-14, SHGC=0.62

Partnering with Saint Gobain Glass, we use the most innovative glass substrates in the world. Our triple-pane glass reaches up to R-14 and SHGC=0.62, giving PH designers greater flexibility when modeling projects in PHPP.

Parameters	
Frame depth	85 - 250 mm 3.35 - 9.84 in
Frame face width	50 mm 2 in

EUROPEAN
ARCHITECTURAL
SUPPLY

North American Distributor
of Fine European Windows
M A K R O W I N

SCHÜCO

144 North Road Suite 2500 |

Sudbury, MA 01776

2013 Copyright © European Architectural Supply, LLC. All Rights Reserved.
Schüco is a registered trademark of Schüco International KG.
Makrovin is a registered trademark of Makrovin s.r.o.
Photos: Schüco International KG
Photos: Greg Pierru Photography
Design: Chin Communications



fine windows
for all seasons

www.finewindows.com

EUROPEAN ARCHITECTURAL SUPPLY | SUPERVISED DELIVERY | INSTALLATION | TRAINING | SERVICE